



for latest edition
and updates **check**
www.powercapacitors.info



PK16™ AND E61

– HIGH DENSITY DC FILM CAPACITORS



THE IDEAL CHOICE FOR YOUR DC LINK

ELECTRONICON®
always in charge

**Choose the best capacitor
for any of your power electronics applications:**

AC and DC capacitors with integrated safety mechanism

E62 AC/DC E62-3ph AC Filter E63 DC

Low-inductance capacitors

E50 PK16™ DC E53 AC/DC E61 DC

Low-inductance High-voltage capacitors

E51

AC and DC capacitors with large capacitance

E56 DC E59 AC/DC E70 AC E50.U SR17™ DC

CAPACITORS

ELECTRONICON®

always in charge

PK16™ and E61

HIGH DENSITY DC FILM CAPACITORS

DC KONDENSATOREN MIT HOHER ENERGIEDICHTE



PK16™ – ideal for your high-current DC-circuit

The PK16™ capacitor can be universally used for the assembly of low inductance DC buffer circuits and DC filters; with its high energy density it can replace banks of series-connected electrolytic capacitors as well as large film capacitors in rectangular cases.

The capacitance in a DC buffer circuit must be sufficiently sized to both handle the current and smoothen the occurring ripple voltages. The traditional use of series-/parallel-connected electrolytic capacitors offered large capacitance at seemingly low cost, however the low cost per microfarad is countered by the low current strength, the high sensitivity to voltage and current surges, as well as high risk of failures in the field, resulting in high maintenance cost.

Our advanced know-how in special capacitor film coating and many years of practical experience in designing and manufacturing capacitors have allowed us to design our PK16™ range with high capacitance density. With fivefold the current strength of conventional electrolytic capacitors, it is not necessary to reproduce the same capacitance in film technology in order to handle a given current.

Instead, the user now gets a superior technical solution within the same – or even less – space, offering

- superior voltage and current strength
- dramatic increase in operational life
- drastic reduction of failures
- minimization of power dissipation losses
- substantial reduction of self-inductance and series resistance
- more exact manufacturing tolerances
- elimination of sharing resistors

Thanks to its compact cylindrical aluminium can design this capacitor is ideal for both the electrical and mechanical requirements of high-speed IGBT converters.

Its robust terminals and the robust fixing stud allow for very simple and reliable mounting that unites lowest inductance and highest current strength. The particularly large clearance and creepage distances make this design suitable for a wide range of operating voltages. As a result, existing standard converter concepts can easily be adapted to new applications without having to change the principal construction and to re-approve the entire system.

PK16™ – Ideal für die hohen Ströme Ihres Zwischenkreises

Der PK16™ Kondensator lässt sich universell zum Aufbau niederinduktiver DC Zwischenkreise und für DC Filter einsetzen und kann mit seiner hohen Energiedichte sowohl Batterien serienschalteter Elektrolytkondensatoren als auch große quaderförmige Folienkondensatoren ersetzen.

Die Kapazität in einem DC-Zwischenkreis muß groß genug sein, um auftretende überlagerte Wechselspannungen zu glätten und entsprechende Rippleströme zu bewältigen. Die traditionelle Serien-/Parallelschaltung von Elektrolytkondensatoren bietet hohe Kapazität zu scheinbar niedrigen Kosten, jedoch steht den geringen Kosten je Mikrofarad eine niedrige Strombelastbarkeit, hohe Stoßstrom- und Spannungsempfindlichkeit sowie ein erhebliches Ausfallrisiko im Feld gegenüber, welches sich in hohen Wartungskosten niederschlägt.

Unser hochentwickeltes Know-How in der Metallisierung von Kondensatorfolien und langjährige praktische Erfahrungen in der Entwicklung und Herstellung von Kondensatoren ermöglichten uns die Schaffung unserer PK16™ Serie mit hoher Kapazitätsdichte. Dank fünffacher Stromfestigkeit gegenüber üblichen Elektrolytkondensatoren ist es nicht mehr notwendig, exakt die gleiche Kapazität in Folientechnologie zu erreichen, um einen gegebenen Strom zu bewältigen.

Statt dessen erhält der Anwender eine hochwertige technische Lösung mit gleichem oder vermindertem Platzbedarf und folgenden Vorteilen:

- höhere Spannungs- und Stromfestigkeit
- drastische Verlängerung der Lebensdauer
- bemerkenswerte Reduzierung von Ausfällen
- Minimierung der Verlustleistung
- erhebliche Verringerung der Eigeninduktivität und des Serienwiderstandes
- genauere Produktionstoleranzen
- Eliminierung von Symmetrierwiderständen

Mit seiner kompakten zylindrischen Bauform in Aluminiumgehäuse ist der Kondensator optimal an elektrische und mechanische Erfordernisse in schnelltaktenden IGBT Stromrichtern angepasst.

Die robusten Anschlusselemente und eine stabile Bodenbefestigung ermöglichen eine besonders einfache Montage, die niedrigste Induktivität und hohe Strombelastbarkeit miteinander vereinigt. Die außerordentlich großen Luft- und Kriechstrecken decken einen weiten Spannungsbereich ab, ohne dass dadurch die Bauform gewechselt werden müsste. Damit kann ein Standard-Stromrichterkonzept sehr viel flexibler auf unterschiedliche Anwendungen ausgerichtet werden, ohne neue Konstruktionen und damit neue Systemprüfungen erforderlich zu machen.



Important notice

Our MKP capacitors of the PK16™ series are made with self-healing dielectric. In the event of voltage breakdowns, caused by weak spots in the dielectric or high thermal/electrical load, the metal coating around the breakdown spot is vaporized within a few microseconds. As a result, the area around the breakdown spot is de-metalized, and the capacitor remains fully functional.

The release of energy during a regular self-healing breakdown, and the amount of gas generated in the process, are so small that even after thousands of such self-healing procedures there is no significant build-up of overpressure inside the capacitor.

The scenario of self-healing breakdown becomes less likely, or impossible, under high thermal or electrical overstress. The disintegration of the polypropylene dielectric may produce more or less amounts of gas accompanied by a build-up of internal pressure. Very frequent and large-scale occurrence of self-healing breakdowns (e.g., as a result of strong voltage overstrain) may cause a gradual rise of the internal pressure of capacitors with hermetically sealed cans as well.

For the sake of lowest available self-inductance and maximum mounting comfort, the capacitors of our PK16™ range are not equipped with an integrated safety mechanism to disconnect them in the event of overload or failure. They should therefore not be operated beyond their rated values and be allocated in uncritical environment (non-inflammable materials) where build-up of pressure or even ignition of the polypropylene cannot cause consequential damage.

Wichtiger Hinweis

Alle in unseren PK16™-Kondensatoren verwendeten dielektrischen Strukturen sind selbstheilend. Im Falle eines Kurzschlusses (z.B. Spannungsdurchschlag an Schwachstellen im Dielektrikum, oder infolge starker thermischer/elektrischer Belastung) verdampfen binnen weniger Mikrosekunden die Metallbeläge rings um den Durchschlagspunkt und bilden eine belagfreie, isolierende Zone. Dabei bleibt der Kondensator voll funktionsfähig.

Die freigesetzte Energie während eines selbstheilenden Durchschlages und die dabei erzeugte Menge an Gas sind so gering, dass selbst nach tausenden solcher Selbstheilungsvorgänge kein nennenswerter Überdruck im Kondensatorinneren entsteht.

Der zuverlässige Ablauf selbstheilender Durchschläge kann jedoch durch hohe thermische oder elektrische Belastung beeinträchtigt oder verhindert werden. Sich zersetzendes Polypropylen erzeugt dann größere Mengen an Gas und der Innendruck im Kondensator steigt. Gleichermaßen können auch häufig und großflächig auftretende Durchschläge (z.B. infolge starker Überspannung) in hermetisch dichten Kondensatoren einen starken Anstieg des Innendrucks verursachen.

Zum Zwecke niedrigster Eigeninduktivität und maximalen Einbaukomforts verfügen die Kondensatoren unserer PK16™ Reihe nicht über einen internen Abschaltmechanismus für Fehlerfälle oder spannungsmäßige Überlastung. Sie sollten daher nicht außerhalb ihrer zulässigen Nennwerte betrieben und stets in unkritischer Umgebung (nichtentflammbare Materialien) platziert werden, wo Gasfreisetzung bzw. ein Entzünden des Dielektrikums keine schwerwiegenden Folgeschäden verursachen können.



for latest edition and updates
check www.powercapacitors.info

E50.*PK16**
DC
600V

Low-inductance DC Capacitors

Niederinduktive Zwischenkreiskondensatoren

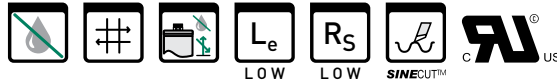

Standards IEC 61071, optional IEC 61881

UL 810

can Gehäuse aluminium/plastic, (UL94: V0)

mounting position optional

Einbaulage beliebig

filling material solid, based on vegetable oil, non-PCB

Füllmittel ausgehärtet, auf Pflanzenölbasis, PCB-frei

internal protection none

interne Sicherung keine

fire load Brandlast 40 MJ/kg

C_N tolerance Toleranz ±10%; optional ±5%

tanδ₀ 2 × 10⁻⁴

limit temperatures Grenztemperaturen

Θ_{min} -40°C

Θ_{max} (HOTSPOT) +85°C¹

storing temperature Lagertemperatur -40°C ... +85°C

Life time Lebensdauer > 200 000 h

Failure rate Ausfallrate 50 FIT²

¹endurance type test_Lebensdauertest: Ø116 @80°C, Ø136 @75°C

²reference service life_Referenzbetriebsdauer 100000 h, Θ_{HOTSPOT} ≤70°C

C _N (µF)	R _s (mΩ)	R _{th} (K/W)	I _{max} (A)	Î (kA)	I _s (kA)	E _N (W _s)	L _e (nH)	D ₁ × L ₁ (mm)	Maßbild Design	m (kg)	order no. Bestell-Nr.	pcs / Box Stk / Box
U_N 600V DC		U_r 100V		U_s 900V		U_{BB} 900V DC		U_{BG} 3300V AC/2s				
555	1	6.7	40	3.8	11.4	100	30	85 × 85	NT	0.5	E50.N85-564NT0	10 / FB9
680	1.1	6	40	3.8	11.5	122	30	85 × 95	NT	0.6	E50.N95-684NT0	10 / FB9
930	1.4	4.7	40	3.8	11.5	167	35	85 × 120	NT	0.7	E50.N12-934NT0	10 / FB10
1035	0.66	4.5	65	7.1	21.3	186	30	116 × 85	NT	1	E50.R85-105NT0	6 / FB9
1110	0.84	3.8	80	7.6	22.9	200	40	85 × 150	NT	0.9	E50.N15-115NT1	5 / FB8
1265	0.71	3.8	65	7.1	21.3	228	30	116 × 100	NT	1.1	E50.R10-135NT0	6 / FB11
1360	0.93	3.3	70	7.6	22.9	245	50	85 × 175	NT	1.1	E50.N17-145NT0	5 / FB8
1450	0.82	3.1	80	10	29.9	261	45	100 × 155	N5	1.3	E50.Q15-155N57	3 / FB8
1725	0.85	3.1	60	7.1	21.3	311	35	116 × 125	NT	1.4	E50.R12-175NT0	6 / FB10
2070	0.62	2.5	90	14.2	42.7	373	45	116 × 155	NT	1.8	E50.R15-215NT0	3 / FB8
2070	0.77	2.1	100	14.2	42.7	373	60	100 × 230	N5	1.9	E50.Q23-215N57	3 / FB9
2430	0.75	2.5	65	10	30	437	40	136 × 129	NT	2	E50.S12-245NT0	2 / FB8
2530	0.66	2.1	90	14.2	42.6	455	50	116 × 180	NT	2.1	E50.R18-255NT0	3 / FB9
3105	0.6	1.7	120	21.3	64	559	60	116 × 220	NT	2.5	E50.R22-315NT0	3 / FB9
3310	0.78	1.7	90	13.6	40.8	596	60	116 × 230	NT	2.6	E50.R23-335NT0	3 / FB9
3795	0.65	1.5	120	21.3	63.9	683	65	116 × 260	NT	3	E50.R26-385NT0	3 / FB10
4140	0.67	1.3	120	28.4	85.3	745	75	116 × 290	NT	3.3	E50.R29-415NT1	3 / FB11
4365	0.62	1.4	120	30	89.9	786	60	136 × 230	NT	3.6	E50.S23-445NT0	2 / FB9
5060	0.75	1.1	120	28.4	85.2	911	85	116 × 340	NT	3.9	E50.R34-515NT0	3 / FB15
5820	0.68	1.1	120	40	119.9	1048	75	136 × 295	NT	4.6	E50.S29-585NT0	2 / FB11
7290	0.76	0.9	120	30	90	1312	85	136 × 345	NT	5.4	E50.S34-735NT0	2 / FB13



DATA CHARTS_DATENTABELLEN_E50.***PK16

Other values and dimensions available on request.
Andere Werte und Abmessungen auf Anfrage erhältlich.



E50.***PK16
DC
700...900V



C_N (μF)	R_s ($\text{m}\Omega$)	R_{th} (K/W)	I_{max} (A)	\hat{I} (kA)	I_s (kA)	E_N (Ws)	L_e (nH)	$D_1 \times L_1$ (mm)	Design	m (kg)	order no. Bestell-Nr.	pcs / Box Stk / Box
U_N 700V DC		U_r 200V		U_s 1050V		U_{BB} 1050V DC		U_{BG} 3300V AC/2s				
410	1.1	6.7	40	3.3	9.9	100	30	85 × 85	NT	0.5	E50.N85-414NT0	10 / FB9
765	0.69	4.5	65	6.1	18.4	187	30	116 × 85	NT	1	E50.R85-774NT0	6 / FB9
820	0.87	3.8	80	6.6	19.7	201	40	85 × 150	NT	0.9	E50.N15-824NT0	5 / FB8
1070	0.81	3.1	80	8.6	25.7	262	45	100 × 155	N5	1.3	E50.Q15-115N57	3 / FB8
1530	0.64	2.5	90	12.3	36.8	375	45	116 × 155	NT	1.8	E50.R15-155NT0	3 / FB8
1545	0.79	2.1	100	12.4	37.1	379	45	100 × 230	N5	1.9	E50.Q23-155N57	3 / FB9
2295	0.62	1.7	120	18.4	55.2	562	60	116 × 220	NT	2.5	E50.R22-235NT0	3 / FB9
3060	0.71	1.3	120	24.5	73.6	750	75	116 × 290	NT	3.3	E50.R29-315NT1	3 / FB11
3240	0.71	1.4	120	26	77.9	794	60	136 × 230	NT	3.6	E50.S23-325NT0	2 / FB9
4320	0.67	1.1	120	34.6	103.8	1058	75	136 × 295	NT	4.6	E50.S29-435NT0	2 / FB11
U_N 900V DC		U_r 200V		U_s 1350V		U_{BB} 1350V DC		U_{BG} 3360V AC/2s				
315	1.1	6.7	40	2.9	8.7	128	30	85 × 85	NT	0.5	E50.N85-324NT0	10 / FB9
385	1.3	6	40	2.9	8.6	156	30	85 × 95	NT	0.6	E50.N95-394NT0	10 / FB9
530	0.82	4.2	80	5.8	17.3	215	40	85 × 136	NT	0.8	E50.N13-534NT0	10 / FB11
580	1.7	4.4	40	2.9	8.6	235	40	85 × 130	NT	0.8	E50.N13-584NT1	5 / FB8
585	0.73	4.5	65	5.4	16.1	237	30	116 × 85	NT	1	E50.R85-594NT0	6 / FB9
630	0.8	3.8	80	5.8	17.3	255	40	85 × 150	NT	0.9	E50.N15-634NT0	5 / FB8
665	1.9	3.9	40	2.9	8.6	269	40	85 × 146	NT	0.9	E50.N14-674NT0	5 / FB8
770	1.1	3.3	65	5.8	17.3	312	50	85 × 175	NT	1.1	E50.N17-774NT0	5 / FB8
820	0.89	3.1	80	7.5	22.5	332	45	100 × 155	N5	1.3	E50.Q15-824N57	3 / FB8
835	2.2	3.3	40	2.9	8.7	338	50	85 × 175	NT	1.1	E50.N17-844NT0	5 / FB8
870	1.6	3.1	40	3.8	11.3	352	45	100 × 155	N5	1.3	E50.Q15-874N57	3 / FB8
980	0.97	3.1	65	5.4	16.1	397	35	116 × 125	NT	1.4	E50.R12-984NT0	6 / FB10
1190	0.91	2.1	80	10.9	32.7	474	60	100 × 230	N5	1.9	E50.Q23-125N57	3 / FB9
1370	1.1	2.1	80	7.5	22.5	555	60	100 × 230	N5	1.9	E50.Q23-145N57	3 / FB9
1380	0.83	2.5	65	7.6	22.7	559	40	136 × 129	NT	2	E50.S12-145NT0	2 / FB8
1555	1.6	2.1	65	5.4	16.1	630	50	116 × 180	NT	2.1	E50.R18-165NT0	3 / FB8
1755	0.63	1.7	120	16.1	48.4	711	60	116 × 220	NT	2.5	E50.R22-185NT0	3 / FB9
1960	0.83	1.7	90	10.8	32.3	794	60	116 × 230	NT	2.6	E50.R23-205NT0	3 / FB9
2340	0.69	1.3	120	21.4	64.3	948	75	116 × 290	NT	3.3	E50.R29-235NT0	3 / FB11
2475	0.6	1.4	120	22.7	68	1002	60	136 × 230	NT	3.6	E50.S23-255NT0	2 / FB9
2940	0.83	1.1	120	16.1	48.4	1191	85	116 × 335	NT	3.8	E50.R33-295NT0	3 / FB15
3110	1.1	1.1	90	10.7	32.2	1260	85	116 × 340	NT	3.9	E50.R34-315NT0	3 / FB15
3300	0.67	1.1	120	30.2	90.7	1337	75	136 × 295	NT	4.6	E50.S29-335NT0	2 / FB11
3500	0.85	1.1	90	15.1	45.4	1418	75	136 × 295	NT	4.5	E50.S29-355NT0	2 / FB11
4140	0.74	0.9	120	22.7	68.1	1677	85	136 × 345	NT	5.4	E50.S34-415NT0	2 / FB13
4390	0.95	0.9	90	15.2	45.5	1778	85	136 × 345	NT	5.4	E50.S34-445NT0	2 / FB13

E50.***PK16
DC
1100...1200V

C_N (μ F)	R_s (m Ω)	R_{th} (K/W)	I_{max} (A)	\hat{I} (kA)	I_s (kA)	E_N (Ws)	L_e (nH)	$D_1 \times L_1$ (mm)	Design	m (kg)	order no. Bestell-Nr.	pcs / Box Stk / Box
U_N 1100V DC		U_r 250V		U_s 1650V		U_{BB} 1650V DC		U_{BG} 3840V AC/2s				
220	1.3	6.7	40	2.4	7.1	133	30	85 × 85	NT	0.5	E50.N85-224NT0	10 / FB9
250	0.73	5.7	70	4.9	14.6	151	30	85 × 100	NT	0.6	E50.N10-254NT0	10 / FB9
280	1.4	6	40	2.5	7.4	169	30	85 × 95	NT	0.6	E50.N95-284NT0	10 / FB9
375	0.67	3.9	90	7.3	21.9	227	40	85 × 146	NT	0.9	E50.N14-384NT0	5 / FB8
380	1.8	4.7	40	2.4	7.3	230	35	85 × 120	NT	0.7	E50.N12-384NT0	10 / FB10
415	0.79	4.5	65	4.5	13.4	251	30	116 × 85	NT	1	E50.R85-424NT0	6 / FB9
420	1.9	4.4	40	2.4	7.3	254	40	85 × 130	NT	0.8	E50.N13-424NT1	5 / FB8
450	0.86	3.8	80	4.8	14.4	272	40	85 × 150	NT	0.9	E50.N15-454NT1	5 / FB8
560	0.95	3.3	80	4.9	14.8	339	50	85 × 175	NT	1.1	E50.N17-564NT0	5 / FB8
580	0.88	3.1	80	6.2	18.7	351	45	100 × 155	N5	1.3	E50.Q15-584N57	3 / FB8
605	2.4	3.3	40	2.5	7.4	366	50	85 × 175	NT	1.1	E50.N17-614NT0	5 / FB8
705	1.1	3.1	65	4.5	13.6	427	35	116 × 125	NT	1.4	E50.R12-714NT0	6 / FB10
790	2	2.7	40	3.2	9.6	478	50	100 × 181	N5	1.5	E50.Q18-794N57	3 / FB8
830	0.68	2.5	90	8.9	26.8	502	45	116 × 155	NT	1.8	E50.R15-834NT0	3 / FB8
855	0.84	2.1	100	9.2	27.6	517	60	100 × 230	N5	1.9	E50.Q23-864N57	3 / FB9
990	1.2	2.1	80	6.4	19.1	599	60	100 × 230	N5	1.9	E50.Q23-994N57	3 / FB9
1000	0.89	2.5	65	6.4	19.3	605	40	136 × 129	NT	2	E50.S12-105NT0	2 / FB8
1100	1.4	2.1	65	4.5	13.5	666	50	116 × 180	NT	2.1	E50.R18-115NT0	3 / FB9
1245	0.65	1.7	120	13.4	40.2	753	60	116 × 220	NT	2.5	E50.R22-125NT0	3 / FB9
1410	0.87	1.7	90	9.1	27.3	853	60	116 × 230	NT	2.6	E50.R23-145NT0	3 / FB9
1660	0.71	1.3	120	17.9	53.6	1004	75	116 × 290	NT	3.3	E50.R29-175NT1	3 / FB11
1755	0.61	1.4	120	18.9	56.7	1062	60	136 × 230	NT	3.6	E50.S23-185NT0	2 / FB9
2115	0.82	1.1	120	13.6	40.9	1280	85	116 × 335	NT	3.8	E50.R33-215NT0	3 / FB15
2200	1.1	1.1	90	9	27.1	1331	85	116 × 340	NT	3.9	E50.R34-225NT1	3 / FB15
2300	0.59	1.1	120	24.8	74.4	1392	75	136 × 295	NT	4.6	E50.S29-235NT0	2 / FB11
3000	0.76	0.9	120	19.3	58	1815	85	136 × 345	NT	5.4	E50.S34-305NT0	2 / FB13
3170	1	0.9	90	12.9	38.6	1918	85	136 × 345	NT	5.4	E50.S34-325NT0	2 / FB13
U_N 1200V DC		U_r 250V		U_s 1800V		U_{BB} 1800V DC		U_{BG} 4080V AC/2s				
185	1.3	6.7	40	2.2	6.6	133	30	85 × 85	NT	0.5	E50.N85-194NT0	10 / FB9
225	1.5	6.0	40	2.2	6.6	162	30	85 × 95	NT	0.6	E50.N95-234NT0	10 / FB9
345	2	4.4	40	2.2	6.7	248	40	85 × 130	NT	0.8	E50.N13-354NT0	5 / FB8
345	0.82	4.5	65	4.1	12.3	248	30	116 × 85	NT	1.0	E50.R85-354NT0	6 / FB10
370	0.99	3.8	75	4.4	13.2	266	40	85 × 150	NT	0.9	E50.N15-374NT0	5 / FB8
600	0.55	2.5	90	7.1	21.3	432	45	116 × 155	NT	1.7	E50.R15-604NT0	3 / FB8
1035	0.69	1.7	120	12.3	37.0	745	60	116 × 220	NT	2.5	E50.R22-105NT0	3 / FB9
1380	0.74	1.3	120	16.4	49.3	994	75	116 × 290	NT	3.3	E50.R29-145NT0	3 / FB10
1940	0.71	1.1	120	23.1	69.3	1397	75	136 × 295	NT	4.6	E50.S29-195NT0	2 / FB11



E50.***PK16
DC
1300...1500V



C _N (µF)	R _S (mΩ)	R _{th} (K/W)	I _{max} (A)	Î (kA)	I _S (kA)	E _N (Ws)	L _e (nH)	D ₁ × L ₁ (mm)	Design	m (kg)	order no. Bestell-Nr.	pcs / Box Stk / Box
U _N 1300V DC		U _r 300V		U _S 1950V		U _{BB} 1950V DC		U _{BG} 4320V AC/2s				
145	1.4	6.7	40	1.9	5.8	123	30	85 × 85	NT	0.5	E50.N85-154NT0	10 / FB9
180	1.6	6	40	2	5.9	152	30	85 × 95	NT	0.6	E50.N95-184NT0	10 / FB9
215	1.9	5.2	40	2	5.9	182	35	85 × 110	NT	0.7	E50.N11-224NT0	10 / FB10
275	0.87	4.5	65	3.7	11	232	30	116 × 85	NT	1	E50.R85-284NT0	6 / FB10
290	1	3.8	75	3.9	11.6	245	40	85 × 150	NT	0.9	E50.N15-294NT0	5 / FB8
335	0.96	3.8	65	3.6	10.9	283	30	116 × 100	NT	1.1	E50.R10-344NT0	6 / FB11
360	1.2	3.3	75	3.9	11.7	304	50	85 × 175	NT	1.1	E50.N17-364NT0	5 / FB8
380	0.94	3.1	80	5	15.1	321	45	100 × 155	N5	1.3	E50.Q15-384N57	3 / FB8
380	1.1	3.5	65	3.5	10.5	321	35	116 × 110	NT	1.3	E50.R11-384NT0	6 / FB11
395	2.8	3.3	40	2	5.9	334	50	85 × 175	NT	1.1	E50.N17-404NT0	5 / FB8
430	1.3	2.8	75	3.9	11.8	363	55	85 × 200	NT	1.2	E50.N20-434NT0	5 / FB9
515	2.3	2.7	40	2.6	7.7	435	50	100 × 181	N5	1.5	E50.Q18-524N57	3 / FB8
550	0.72	2.5	90	7.3	21.9	465	45	116 × 155	NT	1.8	E50.R15-554NT0	3 / FB8
670	0.79	2.1	90	7.3	21.8	566	50	116 × 180	NT	2.1	E50.R18-674NT0	3 / FB8
730	1.6	2.1	65	3.7	11	617	50	116 × 180	NT	2.1	E50.R18-734NT0	3 / FB8
760	0.9	1.9	90	7	20.9	642	55	116 × 205	NT	2.3	E50.R20-764NT0	3 / FB9
825	0.68	1.7	120	11	32.9	697	60	116 × 220	NT	2.5	E50.R22-834NT0	3 / FB9
1005	0.73	1.5	120	10.9	32.7	849	65	116 × 260	NT	3	E50.R26-105NT0	3 / FB10
1100	0.7	1.3	120	14.6	43.8	930	75	116 × 290	NT	3.3	E50.R29-115NT0	3 / FB11
1170	0.63	1.4	120	15.5	46.6	989	60	136 × 230	NT	3.6	E50.S23-125NT0	2 / FB9
1460	1.2	1.1	90	7.3	21.9	1234	85	116 × 340	NT	3.9	E50.R34-155NT0	3 / FB15
1695	0.75	1.1	120	15.6	46.7	1432	75	136 × 310	NT	4.8	E50.S31-175NT0	2 / FB13
2070	1.1	0.9	90	10.4	31.1	1749	85	136 × 345	NT	5.4	E50.S34-215NT0	2 / FB13
U _N 1500V DC		U _r 300V		U _S 2250V		U _{BB} 2250V DC		U _{BG} 4800V AC/2s				
180	0.93	4.6	70	3.4	10.3	203	30	85 × 125	NT	0.8	E50.N12-184NT0	10 / FB10
195	2.2	4.7	40	1.7	5.2	219	35	85 × 120	NT	0.7	E50.N12-204NT0	10 / FB10
255	0.85	3.2	90	4.9	14.7	287	50	85 × 180	NT	1.1	E50.N18-264NT0	5 / FB8
340	0.66	3	90	6.5	19.5	383	40	116 × 130	NT	1.5	E50.R13-344NT0	6 / FB10
365	1.3	3.1	65	3.3	9.8	411	35	116 × 125	NT	1.4	E50.R12-374NT0	6 / FB10
405	1.4	2.8	65	3.3	9.8	456	40	116 × 135	NT	1.5	E50.R13-414NT0	6 / FB10
510	0.62	2.1	120	9.8	29.3	574	50	116 × 185	NT	2.1	E50.R18-514NT0	3 / FB8
510	1.4	2.1	80	4.5	13.6	574	60	100 × 230	NT	1.9	E50.Q23-514N57	3 / FB9
575	1.1	2.3	65	4.6	13.9	647	40	136 × 140	NT	2.2	E50.S14-584NT0	2 / FB8
680	0.59	1.7	120	13	39.1	765	50	116 × 195	NT	3.1	E50.S19-684NT0	3 / FB9
730	1	1.7	90	6.5	19.5	821	60	116 × 230	NT	2.6	E50.R23-734NT0	3 / FB9
810	1	1.5	90	6.5	19.6	911	65	116 × 250	NT	2.9	E50.R25-814NT0	3 / FB10
1095	0.89	1.1	120	9.8	29.3	1232	85	116 × 335	NT	3.8	E50.R33-115NT0	3 / FB15
1150	0.91	1.3	90	9.3	27.8	1294	65	136 × 260	NT	4.1	E50.S26-125NT0	2 / FB11
1545	0.81	0.9	120	13.8	41.3	1738	85	136 × 345	NT	5.4	E50.S34-155NT1	2 / FB13

Other values and dimensions available on request.
Andere Werte und Abmessungen auf Anfrage erhältlich.



E50.***PK16
DC
1800...2000V

C_N (μF)	R_S ($\text{m}\Omega$)	R_{th} (K/W)	I_{max} (A)	\hat{I} (kA)	I_S (kA)	E_N (Ws)	L_e (nH)	$D_1 \times L_1$ (mm)	Design	m (kg)	order no. Bestell-Nr.	pcs / Box Stk / Box
U_N 1800V DC		U_r 400V		U_s 2700V		U_{BB} 2700V DC		U_{BG} 5520V AC/2s				
170	2.9	3.9	40	1.5	4.4	275	40	85 × 146	NT	0.9	E50.N14-174NT0	5 / FB8
220	2.4	3.1	40	1.9	5.7	356	45	100 × 155	N5	1.3	E50.Q15-224N57	3 / FB8
315	1.7	2.6	65	2.7	8.1	510	40	116 × 150	N5	1.7	E50.R15-324NT0	3 / FB8
630	1.2	1.4	90	5.4	16.2	1021	70	116 × 280	NT	3.2	E50.R28-634NT0	3 / FB10
890	1.1	1.1	90	7.6	22.9	1442	75	136 × 295	NT	4.5	E50.S29-894NT0	2 / FB11
U_N 2000V DC		U_r 500V		U_s 3000V		U_{BB} 3000V DC		U_{BG} 6000 V AC/2s				
60	1.8	6.7	40	1.3	3.8	120	30	85 × 85	NT	0.5	E50.N85-603NT0	10 / FB9
70	0.87	5.7	55	2.7	8.2	140	30	85 × 100	NT	0.6	E50.N10-703NT0	10 / FB9
75	2.1	6	40	1.3	3.8	150	30	85 × 95	NT	0.6	E50.N95-753NT0	10 / FB9
90	2.9	5.2	40	1.2	3.6	180	35	85 × 110	NT	0.7	E50.N11-903NT0	10 / FB9
105	2.7	4.7	40	1.3	3.9	210	35	85 × 120	NT	0.7	E50.N12-114NT0	10 / FB10
115	1.1	4.5	60	2.4	7.2	230	30	116 × 85	NT	1	E50.R85-124NT0	6 / FB9
120	1.3	3.8	65	2.5	7.5	240	40	85 × 150	NT	0.9	E50.N15-124NT0	5 / FB8
160	1	3.1	80	3.3	10	320	45	100 × 155	N5	1.3	E50.Q15-164N57	3 / FB8
165	3.8	3.3	40	1.3	3.8	330	50	85 × 175	NT	1.1	E50.N17-174NT0	5 / FB8
170	1.4	3.5	65	2.4	7.3	340	35	116 × 110	NT	1.3	E50.R11-174NT0	6 / FB11
180	1.7	2.8	65	2.6	7.7	360	55	85 × 200	NT	1.2	E50.N20-184NT0	5 / FB9
195	1.6	3.1	65	2.4	7.2	390	35	116 × 125	NT	1.4	E50.R12-204NT0	6 / FB10
230	0.83	2.5	90	4.8	14.4	460	45	116 × 155	NT	1.8	E50.R15-234NT0	3 / FB8
270	1.4	2.1	80	3.3	10	540	60	100 × 230	N5	1.9	E50.Q23-274N57	3 / FB9
275	1.3	2.5	65	3.4	10.2	550	40	136 × 129	NT	2	E50.S12-284NT0	2 / FB8
310	2.1	2.1	65	2.4	7.2	620	50	116 × 180	NT	2.1	E50.R18-314NT0	3 / FB9
345	0.75	1.7	120	7.2	21.6	690	60	116 × 220	NT	2.5	E50.R22-354NT0	3 / FB9
390	1.1	1.7	90	4.8	14.4	780	60	116 × 230	NT	2.6	E50.R23-394NT0	3 / FB9
460	0.76	1.3	120	9.6	28.8	920	75	116 × 290	NT	3.3	E50.R29-464NT0	3 / FB11
480	0.69	1.4	120	10	30.1	960	60	136 × 230	NT	3.6	E50.S23-484NT0	2 / FB9
560	0.82	1.1	120	9.5	28.5	1120	85	116 × 340	NT	3.9	E50.R34-564NT1	3 / FB15
585	0.98	1.1	120	7.2	21.6	1170	85	116 × 335	NT	3.8	E50.R33-594NT0	3 / FB15
620	1.5	1.1	90	4.8	14.3	1240	85	116 × 340	NT	3.9	E50.R34-624NT0	3 / FB15
640	0.65	1.1	120	12.9	38.7	1280	70	136 × 295	NT	4.5	E50.S29-644NT0	2 / FB11
735	0.82	1.1	120	10.5	31.5	1470	75	136 × 310	NT	4.8	E50.S31-744NT0	2 / FB11
825	0.88	0.9	120	10.2	30.5	1650	85	136 × 345	NT	5.4	E50.S34-834NT0	2 / FB13
880	1.3	0.9	90	6.8	20.3	1760	85	136 × 345	NT	5.4	E50.S34-884NT0	2 / FB13



E50.***PK16

DC

2200...2800V



C _N (μF)	R _S (mΩ)	R _{th} (K/W)	I _{max} (A)	I _h (kA)	I _S (kA)	E _N (Ws)	L _e (nH)	D ₁ × L ₁ (mm)	Design	m (kg)	order no. Bestell-Nr.	pcs / Box Stk / Box
U _N 2200V DC		U _r 600V		U _S 3300V		U _{BB} 3300V DC		U _{BG} 6480V AC/2s				
50	1.9	6.7	35	1.2	3.5	121	30	85 × 85	NT	0.5	E50.N85-503NT0	10 / FB9
50	0.96	5.7	50	2.2	6.5	121	30	85 × 100	NT	0.6	E50.N10-503NT0	10 / FB9
85	2.9	4.7	40	1.2	3.5	206	35	85 × 120	NT	0.7	E50.N12-853NT0	10 / FB10
90	1.2	4.5	55	2.1	6.3	218	30	116 × 95	NT	1	E50.R85-903NT0	6 / FB9
95	0.68	3.7	75	4.1	12.3	230	30	116 × 105	NT	1.2	E50.R10-953NT0	6 / FB11
100	1.3	3.8	60	2.3	7	242	40	85 × 150	NT	0.9	E50.N15-104NT0	5 / FB8
130	1.2	3.1	70	3	9.1	315	45	100 × 155	N5	1.3	E50.Q15-134N57	3 / FB8
155	1.7	3.1	60	2.1	6.4	375	35	116 × 125	NT	1.4	E50.R12-164NT0	6 / FB10
170	1.9	2.5	65	2.3	7	411	60	85 × 225	NT	1.4	E50.N22-174NT0	5 / FB9
180	0.88	2.5	90	4.2	12.6	436	45	116 × 155	NT	1.8	E50.R15-184NT0	3 / FB8
220	1.5	2.1	80	3	9.1	532	60	100 × 230	N5	1.9	E50.Q23-224N57	3 / FB9
220	1.3	2.5	65	3	9.1	532	40	136 × 129	NT	2	E50.S12-224NT0	2 / FB8
270	0.78	1.7	120	6.3	18.8	653	60	116 × 220	NT	2.5	E50.R22-274NT0	3 / FB9
310	1.2	1.7	90	4.3	12.8	750	60	116 × 230	NT	2.6	E50.R23-314NT0	3 / FB9
360	0.78	1.3	120	8.4	25.1	871	75	116 × 290	NT	3.3	E50.R29-364NT0	3 / FB11
390	0.7	1.4	120	9.1	27.2	944	60	136 × 230	NT	3.6	E50.S23-394NT0	2 / FB9
465	1	1.1	120	6.4	19.2	1125	85	116 × 335	NT	3.8	E50.R33-474NT0	3 / FB15
520	0.72	1.1	120	12.1	36.3	1258	75	136 × 295	NT	4.6	E50.S29-524NT0	2 / FB11
660	0.89	0.9	120	8.9	26.7	1597	85	136 × 345	NT	5.4	E50.S34-664NT0	2 / FB13
U _N 2600V DC		U _r 600V		U _S 3900V		U _{BB} 3900V DC		U _{BG} 7440V AC/2s				
95	2.9	3.3	40	1.9	5.8	321	50	85 × 175	NT	1.1	E50.N17-953NT0	5 / FB8
120	2.4	2.7	40	2.5	7.4	406	50	100 × 181	NT	1.5	E50.Q18-124N57	3 / FB8
175	1.6	2.1	65	3.6	10.7	592	50	116 × 180	NT	2.1	E50.R18-184NT0	3 / FB8
350	1.2	1.1	90	7.2	21.5	1183	85	116 × 340	NT	3.9	E50.R34-354NT1	3 / FB15
490	1.1	0.9	90	10	30.1	1656	85	136 × 345	NT	5.4	E50.S34-494NT0	2 / FB13
U _N 2800V DC		U _r 600V		U _S 4200V		U _{BB} 4200V DC		U _{BG} 7920V AC/2s				
80	3	3.3	40	1.7	5.2	314	50	85 × 175	NT	1.1	E50.N17-803NT0	5 / FB8
105	2.5	2.7	40	2.3	6.9	412	50	100 × 181	NT	1.5	E50.Q18-114N57	3 / FB8
150	1.7	2.1	60	3.3	9.8	588	50	116 × 180	NT	2.1	E50.R18-154NT0	3 / FB9
300	1.3	1.1	90	6.6	19.7	1176	85	116 × 340	NT	3.9	E50.R34-304NT0	3 / FB15
430	1.1	0.9	90	9.4	28.2	1686	85	136 × 345	NT	5.4	E50.S34-434NT1	2 / FB13

E50.***PK16
DC
3000...3600V

C_N (μF)	R_S ($\text{m}\Omega$)	R_{th} (K/W)	I_{max} (A)	\hat{I} (kA)	I_S (kA)	E_N (Ws)	L_e (nH)	$D_1 \times L_1$ (mm)	Design	m (kg)	order no. Bestell-Nr.	pcs / Box Stk / Box
U_N 3000V DC		U_r 600V		U_S 4500V		U_{BB} 4500V DC		U_{BG} 8400V AC/2s				
45	2.2	4.7	40	1.7	5	203	35	85 × 120	NT	0.7	E50.N12-453NT0	10 / FB10
50	2.9	3.9	40	1.5	4.5	225	40	85 × 146	NT	0.9	E50.N14-503NT0	5 / FB8
70	2.3	3.1	40	2.1	6.3	315	45	100 × 155	N5	1.3	E50.Q15-703N57	3 / FB8
75	3.1	3.3	40	1.7	5.1	338	50	85 × 175	NT	1.1	E50.N17-753NT0	5 / FB8
85	1.3	3.1	65	3.1	9.4	383	35	116 × 125	NT	1.4	E50.R12-853NT0	6 / FB10
95	2.6	2.7	40	2.2	6.5	428	50	100 × 181	N5	1.5	E50.Q18-953N57	3 / FB8
100	1.6	2.6	65	3	9.1	450	40	116 × 150	NT	1.7	E50.R15-104NT0	3 / FB8
120	1	2.5	65	4.4	13.3	540	40	136 × 129	NT	2	E50.S12-124NT0	2 / FB8
120	1.4	2.1	80	4.4	13.3	540	60	100 × 230	N5	1.9	E50.Q23-124N57	3 / FB9
135	1.8	2.1	65	3.1	9.3	608	50	116 × 180	NT	2.1	E50.R18-144NT0	3 / FB9
170	0.98	1.7	90	6.3	18.8	765	60	116 × 230	NT	2.6	E50.R23-174NT1	3 / FB9
200	1.2	1.4	90	6	18.1	900	70	116 × 280	NT	3.2	E50.R28-204NT0	3 / FB10
255	0.89	1.1	120	9.4	28.2	1148	85	116 × 335	NT	3.8	E50.R33-264NT0	3 / FB15
280	1	1.1	90	8.5	25.4	1260	75	136 × 295	NT	4.5	E50.S29-284NT1	2 / FB11
360	0.81	0.9	120	13.3	39.8	1620	85	136 × 345	NT	5.4	E50.S34-364NT1	2 / FB13
390	1.1	0.9	90	8.9	26.8	1755	85	136 × 345	NT	5.4	E50.S34-394NT0	2 / FB13
U_N 3200V DC		U_r 700V		U_S 4800V		U_{BB} 4800V DC		U_{BG} 8880V AC/2s				
45	2.9	3.9	40	1.5	4.5	230	40	85 × 146	NT	0.9	E50.N14-453NT0	5 / FB8
55	2.5	3.1	40	1.8	5.5	282	45	100 × 155	N5	1.3	E50.Q15-553N57	3 / FB8
80	1.7	2.6	65	2.7	8	410	40	116 × 150	NT	1.7	E50.R15-803NT0	3 / FB8
160	1.2	1.4	90	5.3	16	819	70	116 × 280	NT	3.2	E50.R28-164NT0	3 / FB10
235	1.1	1.1	90	7.8	23.5	1203	75	136 × 295	NT	4.5	E50.S29-244NT0	2 / FB11
U_N 3600V DC		U_r 850V		U_S 5400V		U_{BB} 5400V DC		U_{BG} 9840V AC/2s				
30	2.5	4.7	35	1.4	4.1	194	35	85 × 120	NT	0.7	E50.N12-303NT0	10 / FB10
40	3	3.9	40	1.4	4.3	259	40	85 × 146	NT	0.9	E50.N14-403NT0	5 / FB8
50	2.5	3.1	40	1.8	5.3	324	45	100 × 155	N5	1.3	E50.Q15-503N57	3 / FB8
55	1.5	3.1	60	2.7	7.5	356	35	85 × 225	NT	1.4	E50.R12-553NT0	5 / FB9
80	1.5	2.1	80	3.7	11	518	60	100 × 230	N5	1.9	E50.Q23-803N57	3 / FB9
80	1.2	2.5	65	3.7	11	518	40	136 × 129	NT	2	E50.S12-803NT0	2 / FB8
110	1.1	1.7	90	5	15.1	713	60	116 × 230	NT	2.6	E50.R23-114NT0	3 / FB9
145	1.3	1.4	90	5.2	15.5	940	70	116 × 280	NT	3.2	E50.R28-154NT0	3 / FB10
165	0.95	1.1	120	7.5	22.6	1069	85	116 × 335	NT	3.9	E50.R33-174NT0	3 / FB15
210	1.1	1.1	90	7.1	21.4	1361	75	136 × 295	NT	4.6	E50.S29-214NT1	2 / FB11
240	0.85	0.9	120	11	32.9	1555	70	136 × 345	NT	5.4	E50.S34-244NT0	2 / FB13



NT ø85/116



NT ø136



Drawings Maßbilder

NT ø85/116

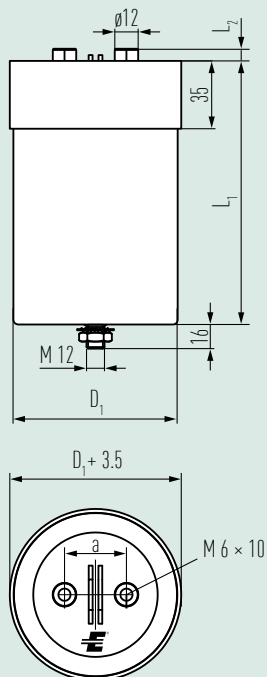

NT ø136

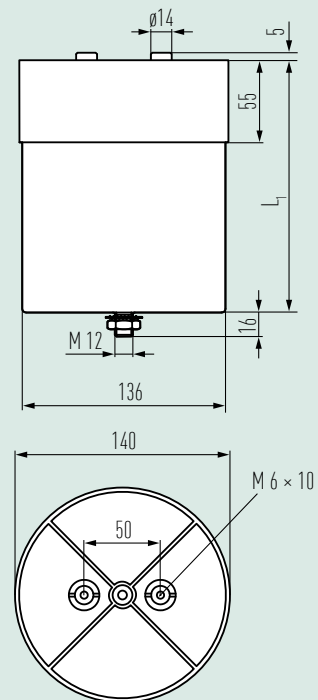

E50 CAPACITORS WITH A CAN DIAMETER OF 85...136 mm

Can material aluminium, filled with solid PU resin
 Base mounting stud M12
 Lid plastic (UL94: V0)
 Terminals internal thread M6 × 10 mm (4 Nm)
 Degree of protection IP 00
 Humidity Class F

E50 KONDENSATOREN MIT EINEM GEHÄUSEDURCHMESSER VON 85...136 mm

Gehäusematerial Aluminium, gefüllt mit ausgehärtetem Polyurethanharz
 Bodenschraube M12
 Deckel Kunststoff (UL94: V0)
 Anschlüsse Innengewinde M6 × 10 mm (4 Nm)
 Schutzgrad IP 00
 Feuchteklasse F

	K	L	L ₂	a	I _{max} (Terminals Anschlüsse)
NT ø85	36	20	6	32	90 A
NT ø116	45	35	5	50	120 A
NT ø136	45	35	5	50	120 A

N5 ø100



Drawings Maßbilder

N5

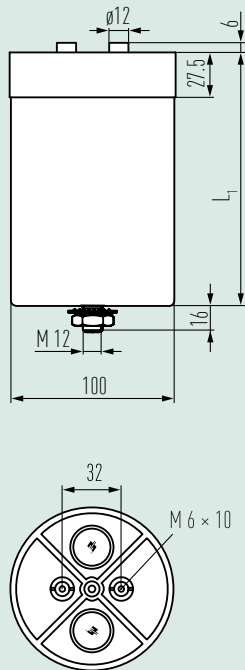

E50 CAPACITORS WITH A CAN DIAMETER OF 100 mm

Can material	aluminium, filled with solid PU resin
Base mounting stud	M12
Lid	plastic (UL94: V0)
Terminals	internal thread M6 × 10 mm (4 Nm)
I_{max} (Terminals)	80 A
Degree of protection	IP 00
K	36
L	20
Humidity Class	F

E50 KONDENSATOREN MIT EINEM GEHÄUSEDURCHMESSER VON 100 mm

Gehäusematerial	Aluminium, gefüllt mit ausgehärtetem Polyurethanharz
Bodenschraube	M12
Deckel	Kunststoff (UL94: V0)
Anschlüsse	Innengewinde M6 × 10 mm (4 Nm)
I_{max} (Anschlüsse)	80 A
Schutzgrad	IP 00
K	36
L	20
Feuchteklasse	F



ACCESSORIES ZUBEHÖR



Holding Brackets for PK16

To fulfill specific shock and vibration requirements, tall capacitors may not be sufficiently fixed by their mounting stud alone. These brackets of glass-fibre reinforced plastic (UL94-V0) with internal brass thread are designed to link capacitors of our PK16 series with diameters of 116 and 136mm with each other and create additional mechanical stabilization during transport and application by anchoring them in the base plate. This construction has been tested successfully for compliance with railway shock and vibration standard IEC EN 61373.

The position of the holders can be arranged at will. Each capacitor should, however, be held by at least two, ideally by three or four brackets which should be allocated as symmetrically as possible. Achieve optimum stability by using the triple brackets for interlinking neighboring capacitor units.

Due to the internal temperature rise, capacitors are subject to slight expansion during operation. Use elastical plastic thread bars only for the link with the base plate to compensate for such expansion. 1m rods, washers and M8 full nuts can be provided as a kit along with the brackets.

Halteklammern für PK16

Um speziellen Anforderungen an die Stoß- und Schwingungsbeständigkeit zu genügen, reicht bei hohen Kondensatoren die Befestigung allein mittels Bodenbolzen u.U. nicht aus. Diese Klammern aus glasfaserverstärktem Kunststoff (UL94-V0) mit Messinggewinde sind für die Verankerung von PK16-Kondensatoren der Durchmesser 116 und 136 untereinander und mit dem Montageuntergrund gedacht und schaffen zusätzliche Stabilität für Transport und Betrieb. Die Konstruktion wurde erfolgreich nach IEC EN 61373 (Betriebsmittel von Bahnfahrzeugen – Prüfungen für Schwingen und Schocken) getestet.

Die Position der Halter kann nach Belieben gestaltet werden. Jeder Kondensator sollte jedoch mindestens durch zwei, besser drei oder vier, möglichst symmetrisch angeordnete Klammern fixiert werden. Verwenden Sie für optimale Stabilität die Dreier-Klammern, um benachbarte Kondensatoren miteinander zu verbinden.

Infolge Erwärmung dehnen sich Kondensatoren im Betriebszustand etwas aus. Verwenden Sie für die Verankerung in der Grundplatte ausschließlich elastische Zahnstangen aus Kunststoff, um eine solche Ausdehnung auszugleichen. 1-Meter-Zahnstangen, M8-Vollmutter und Zahnscheiben können als Zubehör geliefert werden.

Description Beschreibung	Qty/set Menge/Set	order no. Bestell-Nr.
single bracket Einzelhalter	10	
full size nut Vollmutter M8	10	E50.H01-10M8A8
toothed washer Zahnscheibe A 8.4	10	
triple bracket Dreifachhalter	10	
full size nut Vollmutter M8	10	E50.H03-10M8A8
toothed washer Zahnscheibe A 8.4	10	
threaded plastic rod Plastikzahnstange l = 1.0 m, M8, Polyamide 6.6	10	E50.GM8-PA1000

Required length of threaded rod Erforderliche Länge der Zahnstange:

$$L_{rod} = L_1 - 22mm + Y$$

L_{rod} Length of rod Länge der Zahnstange
 L_1 Length of capacitor case Gehäuselänge des Kondensators
 Y Thickness of mounting base Dicke der Montagebasis

Drawings Maßbilder

triple bracket Dreifachhalter

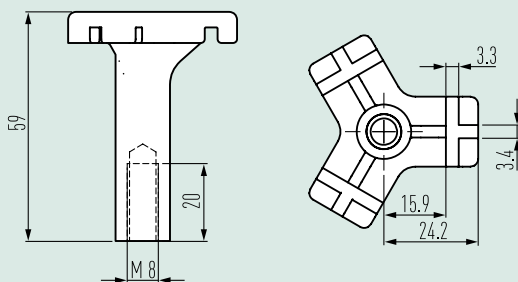

single bracket Einzelhalter

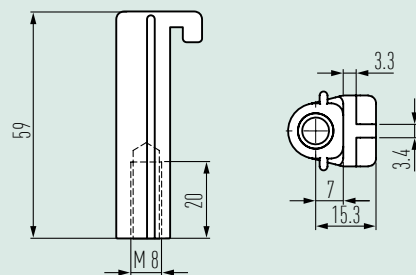



Suggested arrangements Einbauvorschläge

symmetrical installation symmetrische Anordnung

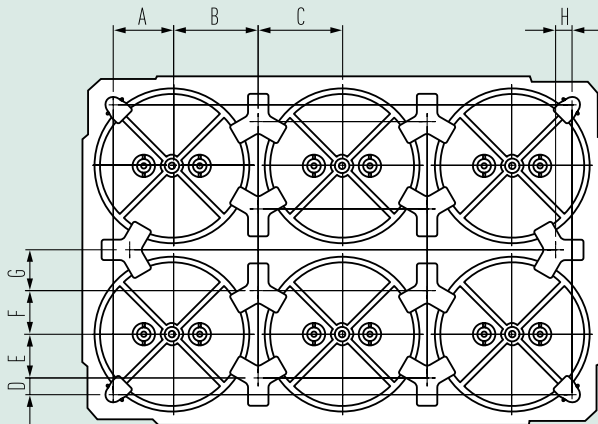

	Ø 116		Ø 136	
	N1	NT	N1	NT
A	46.5	47.5	53.3	54.5
B	64.5	66	74.5	76.3
C	64.5	66	74.5	76.3
D	9.5	10.5	14.8	15.5
E	37	37	38.5	39
F	37	37	38.5	39
G	27.5	29	36	37.3
H	9.5	10.5	14.5	15.8

shifted installation versetzte Anordnung

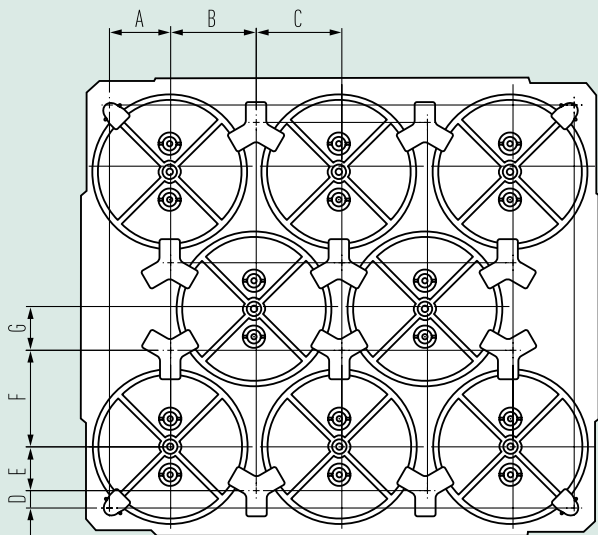

	Ø 116		Ø 136	
	N1	NT	N1	NT
A	46.5	47.5	53.3	54.5
B	64.5	66	74.5	76.3
C	64.5	66	74.5	76.3
D	9.5	10.5	14.8	15.5
E	37	37	38.5	39
F	74.5	76	84.3	86
G	35.5	38	40.8	39



Terminal Adapter

Customers who wish to connect their capacitors by male M8 terminals can upgrade our standard NT design by means of these adapters.

Please note: By inserting the adapters, the terminal level is elevated by 3mm.

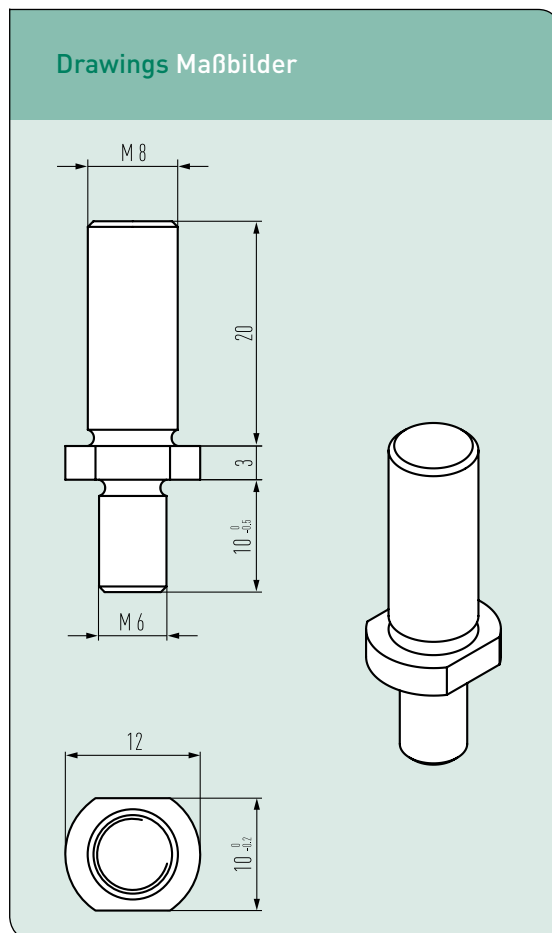

Anschlussadapter M6x10-M8x20

Kunden, welche für ihre Anwendung Gewindebolzen mit M8 Außengewinde bevorzugen, können die Anschlüsse unserer Standardausführung NT mithilfe dieser Adapter nachrüsten.

Bitte beachten Sie, daß die Anschlußebene hierbei um 3mm angehoben wird.

Order no. Bestellnr..... 200.050-A20970

material Material..... tinned brass Messing, verzinkt

thread Gewinde..... M6 × 10 mm / M8 × 20 mm

fixing torque Drehmoment..... 4 Nm

max. rms current max. Effektivstrom..... 80 A

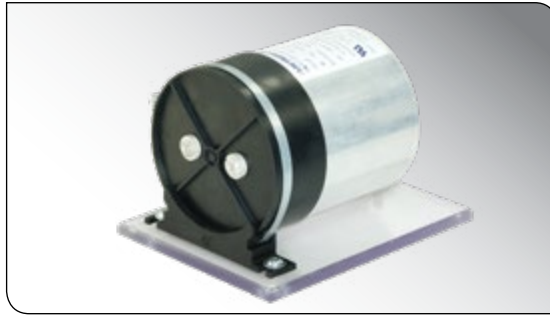

Holder for Horizontal Mounting

Capacitors with diameter 136mm can be mounted by means of this bracket on a flat vertical or horizontal surface.

The bracket is made of glass fibre reinforced polyamide and comes as a set including a matching 9mm zinc-plated steel strap with screw thread for fixation of the capacitor.

Halter für waagrechte Montage

Kondensatoren mit Durchmesser 136mm können mit Hilfe dieser Schelle auf einer senkrechten oder waagerechten Oberfläche montiert werden.

Der Halter ist aus glasfaserverstärktem Polyamid und wird inkl. passender 9mm Schlauchschelle aus verzinktem Stahl mit Schneckengewinde für die Fixierung geliefert.

Drawings Maßbilder

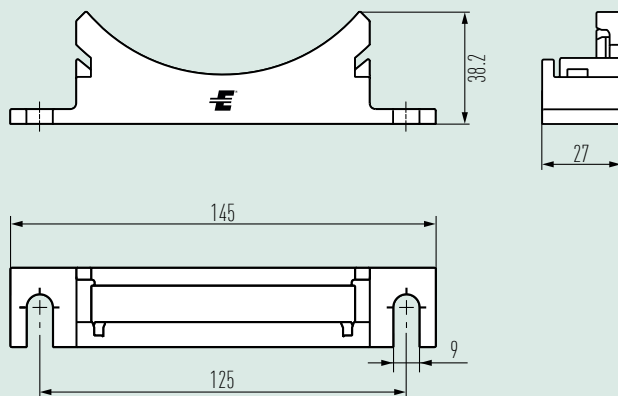

Suggested Arrangements Einbauvorschläge

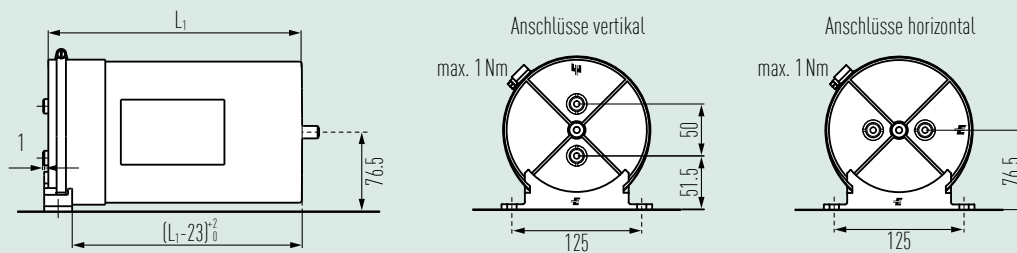

Order no. Bestellnr..... 200.520-020005



THE LOW-CAPACITANCE BUFFER CIRCUIT DER KAPAZITÄTSARME ZWISCHENKREIS

3-Phase Frequency converters with Low-Capacitance DC-Link (LCDC)

Robots, elevators, assembly lines, processing centers, tooling machines – high process speed and further improvement of automation levels are unthinkable without frequency controlled AC drives. And it would not be possible to achieve the optimum operating characteristics at an economically feasible utilization level of available resources.

Most of the contemporary 3-phase frequency converters are working with a DC link, mainly using electrolytic capacitors to buffer the DC voltage. When selecting the electrolytic capacitors, the dominating criteria are the AC current load and the required operating life time. As a rule, this leads to the installation of large banks of electrolytic capacitors even though the large capacitance as such would not even be necessary for the buffering as such. These days, decentralized motors with integrated drive are becoming more and more popular. The advantages of this topology are more intelligent and flexible interconnection and control of the individual systems, as well as simplified and more convenient maintenance conditions. At the same time, developers are tasked to improve the technical performance of the electronic drives, reduce their mechanical dimensions and – of course – cost.



The „LCDC“ (DC buffer circuit with low, or small, capacitance) complies with all these requirements and has become possible with the high density DC film capacitors designed and manufactured by ELECTRONICON.

The capacitors of the E61 series are optimized for use in DC Link circuits with high rms and surge currents. The pin terminals allow for direct integration into your printed circuit board.

The winding is placed inside a flame retardant housing filled with solid resin (PUR). In order to minimize self-inductance and dimensions, the E61-capacitors are not equipped with an internal fail-safe device. Capacitors with their comparably high fire load (appr. 40MJ/kg) do always bear a certain risk of collateral damage in the event of a failure. It is therefore necessary to place them in uncritical environment or integrate other proper measures of prevention.

Frequenzumrichter am 3-Netz mit kapazitätsarmem Zwischenkreis

Ob Roboter, Aufzüge, Fertigungsstraßen, Bearbeitungszentren, Werkzeugmaschinen - ohne frequenzgesteuerte Drehstromantriebe sind hohe Prozessgeschwindigkeiten und eine weitere Verbesserung des Automatisierungsgrades nicht zu erreichen. Ebenso wenig wäre es möglich, die optimale Betriebscharakteristik bei einem aus betriebswirtschaftlicher Sicht günstigen Einsatz der vorhandenen Mittel zu erreichen.

Die meisten der heute eingesetzten 3-Netz Frequenzumrichter arbeiten mit einem Gleichspannungszwischenkreis. Zur Pufferung der Gleichspannung werden überwiegend Elektrolyt-Kondensatoren verwendet. Bei deren Dimensionierung sind die Wechselstrombelastung und die geforderte Lebensdauer die entscheidenden Kriterien. Dies führt zumeist zum Einsatz großer Batterien von Elektrolyt-Kondensatoren, obwohl die Gesamtkapazität zur Pufferung gar nicht benötigt wird. Zur Zeit gewinnen dezentral aufgestellte Motoren mit integriertem Antrieb immer mehr an Bedeutung. Die Vorteile dieser Topologie liegen in der flexibleren und intelligenteren Vernetzung und Ansteuerung der einzelnen Systeme, sowie in einem übersichtlicheren Wartungsaufwand. Einhergehend mit dieser Technologie werden an die Entwickler die Forderungen gestellt, die technische Performance der elektronischen Antriebe zu verbessern, die mechanischen Abmaße zu verkleinern und die Kosten zu reduzieren.

Eine Alternative, die allen diesen Forderungen gerecht wird, ist der „Niederkapazitive Gleichspannungszwischenkreis“, welcher dank der von ELECTRONICON entwickelten HD-DC-Kondensatoren möglich wurde.

E61-Kondensatoren sind optimal für die Anwendung in Gleichspannungszwischenkreisen mit hohen Effektiv- und Spitzenströmen. Die Pin-Anschlüsse können zur direkten Montage auf der Leiterplatte genutzt werden. Der Kondensatorwickel ist in einem flammhemmenden Gehäuse untergebracht und mit Harz vergossen. Die Forderung minimierter Eigeninduktivität und Gehäuseabmessungen lässt bei Kondensatoren dieser Bauart keinen integrierten Sicherheitsmechanismus zu. Da Kondensatoren mit ihrer verhältnismäßig hohen Brandlast (ca. 40MJ/kg) im Fehlerfall stets ein gewisses Risiko für Folgeschäden bergen, ist es geboten, sie nur in unkritischer Umgebung oder in Verbindung mit zusätzlichen Vorbeugemaßnahmen zu installieren.

Example

Comparison between a DC link with electrolytic capacitors and film capacitors of our E61 series (5kW drive, $\Theta_{\text{ambient}} = 70^\circ\text{C}$, target life time > 50.000 h):

Beispiel

Vergleich zwischen Gleichspannungszwischenkreisen mit Elektrolyt-Kondensatoren und solchen mit E61-Folienkondensatoren (5kW Umrichter, $\Theta_{\text{Umgebung}} = 70^\circ\text{C}$, angestrebte Lebensdauer > 50.000 h):

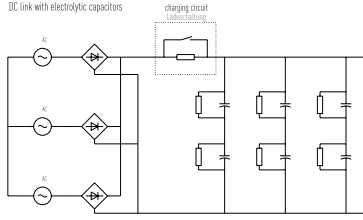
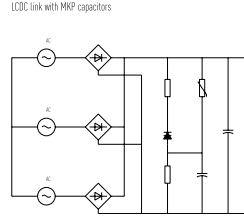
	Elyt* 1300 μF /450V	E61 48 μF /900V
Circuitry	DC link with electrolytic capacitors 	LCDC link with MKP capacitors 
ESR/300Hz	110 m Ω	4.3 m Ω
$I_{\text{rms}}/300\text{Hz}$	8 A	35 A
D x L	40 x 96 mm	50 x 57 mm
Volume per unit Volumen pro Einheit	120 cm ³	112 cm ³
Weight per unit Gewicht pro Einheit	170 g	120 g
Required quantity Benötigte Menge	6	1
Total volume installed Installiertes Gesamtvolumen	6 x 120 cm ³ = 720 cm ³	112 cm ³
Total weight installed Installiertes Gesamtgewicht	6 x 170 g = 1020 g	120 g

* example: market leading manufacturer
* Beispiel: marktführender Hersteller

Interactions with mains

The comparison of mains currents in the graphic to the right shows that the necessity for filtering is substantially reduced as well:

Netrückwirkungen

Die in der Grafik zur rechten dargestellten Netzströme bedürfen hinsichtlich des erforderlichen Filteraufwandes sicher keines Kommentars:

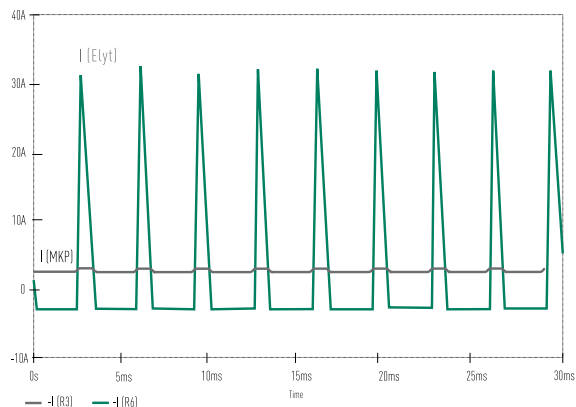

Cost advantages

Presuming that the expenses for the sharing resistors and the charging circuit of the electrolytic capacitors equals more or less the cost of the additional buffering for the MKP circuit, we get a cost reduction by factor 5 when using MKP capacitors instead of electrolytic capacitors. This does not yet consider indirect savings by improved reliability of the final product, reduced power losses a.o.

Kostenvorteil

Unter der Annahme, dass der Aufwand für die Ladeschaltung und die Symmetrierung der Elektrolytkondensatoren etwa genauso hoch ist wie die erforderliche Pufferschaltung beim MKP-Zwischenkreis, ergibt sich eine Kostenreduktion um den Faktor 5 beim Einsatz von MKP-Kondensatoren anstelle von Elektrolytkondensatoren.



E61.***
DC
500...900V

for latest edition and updates
check www.powercapacitors.info



Low-inductance DC capacitors for PCB mounting
Niederinduktive DC-Kondensatoren für Leiterplattenmontage



Standards..... IEC 61071, optional IEC 61881, UL 810
can Gehäuse..... plastic Kunststoff (UL94: V0)
mounting position..... optional
Einbaulage..... beliebig
filling material..... solid, based on vegetable oil, non-PCB
Füllmittel..... ausgehärtet, auf Pflanzenölbasis, PCB-frei
internal protection..... none
interne Sicherung..... keine
fire load Brandlast..... 40 MJ/kg

C_N tolerance Toleranz ±10%
tanδ₀ 2 × 10⁻⁴
limit temperatures Grenztemperaturen
Θ_{min} ... Θ_{max} -25°C ... +85°C
Θ_{HOTSPOT} +85°C
storing temperature Lagertemperatur -40°C ... +85°C
Life time Lebensdauer > 200 000 h
Failure rate Ausfallrate 50 FIT
(reference service life_Referenzbetriebsdauer 100 000 h, Θ_{HOTSPOT} ≤70°C)



C _N (μF)	R _S (mΩ)	R _{th} (K/W)	I _{max} (A)	Î (kA)	I _S (kA)	E _N (Ws)	L _e (nH)	D ₁ × L ₁ (mm)	Design Maßbild	m (kg)	order no. Bestell-Nr.
U_N 500V DC		U_S 750V		U_r 170V		U_{BB} 750V DC					
85	2	10.9	35	1.1	3.3	11.9	45	50 × 57	P3	0.12	E61.G57-853P3C
195	3.4	7.4	25	1.1	3.3	24.4	66	50 × 95	P3	0.18	E61.G95-204P3C
208	0.79	7.5	50	2.6	8	26	15	75 × 56	P57	0.3	E61.M56-214P57
260	5.2	6.1	30	1.1	3.3	32.5	110	50 × 120	P3	0.21	E61.G12-264P3C
358	0.64	4.7	70	4	13	45	20	95 × 56	P57	0.48	E61.P56-364P57
542	0.57	3.1	80	8	26	68	25	95 × 83	P57	0.7	E61.P83-544P57
645	0.84	3.1	70	4	13	81	25	95 × 83	P57	0.7	E61.P83-654P57
U_N 700V DC		U_S 1050V		U_r 200V		U_{BB} 1050V DC					
58	1.9	10.9	30	0.9	2.7	14.2	45	50 × 57	P3	0.12	E61.G57-583P3C
142	3.5	7.4	30	0.93	2.8	34.8	66	50 × 95	P3	0.18	E61.G95-144P3C
154	0.85	7.5	50	2.2	7	38	15	75 × 56	P57	0.3	E61.M56-154P57
190	4.7	6.1	25	0.91	2.73	46.6	66	50 × 120	P3	0.21	E61.G12-194P3C
265	0.67	4.7	65	4	11	65	20	95 × 56	P57	0.48	E61.P56-274P57
402	0.58	3.1	80	8	22	98	25	95 × 83	P57	0.7	E61.P83-404P57
480	0.89	3.1	70	4	11	118	25	95 × 83	P57	0.7	E61.P83-484P57
U_N 900V DC		U_S 1350V		U_r 200V		U_{BB} 1350V DC					
36	2.4	10.9	35	0.7	2.1	14.6	45	50 × 57	P3	0.12	E61.G57-363P3C
45	2.1	10.9	35	0.8	2.4	18.2	45	50 × 57	P3	0.12	E61.G57-453P3C
48	2.2	10.9	35	0.85	2.55	19.4	45	50 × 57	P3	0.12	E61.G57-483P3C
112	4.1	7.4	32	0.84	2.52	43.7	66	50 × 95	P3	0.18	E61.G95-114P3C
118	0.91	7.5	45	2	6	48	15	75 × 56	P57	0.3	E61.M56-124P57
155	6	6.1	30	0.85	2.55	62.8	66	50 × 120	P3	0.21	E61.G12-164P3C



C_N (μF)	R_S ($m\Omega$)	R_{th} (K/W)	I_{max} (A)	\hat{I} (kA)	I_S (kA)	W_N (Ws)	L_p (nH)	$D_1 \times L_1$ (mm)	Design Maßbild	m (kg)	order no. Bestell-Nr.
U_N 900V DC		U_S 1350V		U_r 260V		U_{BB} 1350V DC					
203	0.7	4.7	65	3	10	82	20	95 × 56	P57	0.48	E61.P56-204P57
308	0.6	3.1	80	6	20	125	25	95 × 83	P57	0.7	E61.P83-314P57
367	0.95	3.1	70	3	10	149	25	95 × 83	P57	0.7	E61.P83-374P57
U_N 1100V DC		U_S 1650V		U_r 250V		U_{BB} 1650V DC					
30	2.8	10.9	20	0.64	1.92	18.2	45	50 × 57	P3	0.12	E61.G57-303P3C
73	4.5	7.4	25	0.66	1.98	44	66	50 × 95	P3	0.18	E61.G95-733P3C
83.5	1.01	7.5	40	1.6	5	51	15	75 × 56	P57	0.3	E61.M56-843P57
100	6.1	6.1	25	0.66	1.98	60.5	66	50 × 120	P3	0.21	E61.G12-104P3C
144	0.76	4.7	60	2.8	8	87	20	95 × 56	P57	0.48	E61.P56-144P57
218	0.62	3.1	80	5.6	16	132	25	95 × 83	P57	0.7	E61.P83-224P57
260	1.05	3.1	65	2.8	8	157	25	95 × 83	P57	0.7	E61.P83-264P57
U_N 1300V DC		U_S 1950V		U_r 300V		U_{BB} 1950V DC					
12	4	10.9	20	0.38	1.14	10	45	50 × 57	P3	0.12	E61.G57-123P3C
16.5	3	10.9	20	0.47	1.41	14	45	50 × 57	P3	0.12	E61.G57-173P3C
40.5	5.7	7.4	25	0.49	1.47	34	66	50 × 95	P3	0.18	E61.G95-413P3C
55	7.7	6.1	25	0.49	1.47	46	66	50 × 120	P3	0.21	E61.G12-553P3C
56	1.13	7.5	40	1.3	4	47	15	75 × 56	P57	0.3	E61.M56-563P57
96	0.84	4.7	60	2.3	7	81	20	95 × 56	P57	0.48	E61.P56-963P57
145	0.65	3.1	75	4.6	14	123	25	95 × 83	P57	0.7	E61.P83-154P57
173	1.17	3.1	60	2.3	7	146	25	95 × 83	P57	0.7	E61.P83-174P57
U_N 2000V DC		U_S 3000V		U_r 500V		U_{BB} 3000V DC					
24	1.42	7.5	35	0.9	2.8	48	15	75 × 56	P57	0.3	E61.M56-243P57
41.5	1	4.7	50	1.6	5	83	20	95 × 56	P57	0.48	E61.P56-423P57
63	0.71	3.1	75	3.2	10	126	25	95 × 83	P57	0.7	E61.P83-633P57
72	1.48	3.1	55	1.5	5	144	25	95 × 83	P57	0.7	E61.P83-723P57
U_N 2200V DC		U_S 3300V		U_r 600V		U_{BB} 3300V DC					
18	1.62	7.5	35	0.8	2.3	44	15	75 × 56	P57	0.3	E61.M56-183P57
31	1.12	4.7	50	1.3	4	75	20	95 × 56	P57	0.48	E61.P56-313P57
50	0.73	3.1	70	3	10	121	25	95 × 83	P57	0.7	E61.P83-503P57
58	1.68	3.1	50	1.4	4	140	25	95 × 83	P57	0.7	E61.P83-583P57
U_N 2600V DC		U_S 3900V		U_r 600V		U_{BB} 3900V DC					
12	1.24	7.5	35	1.3	4	41	15	75 × 56	P57	0.3	E61.M56-123P57
21	0.89	4.7	50	2.2	7	71	20	95 × 56	P57	0.48	E61.P56-213P57
40	1.23	3.1	50	2.2	7	135	25	95 × 83	P57	0.7	E61.P83-403P57



E61.***

DC

3300...4000V



C_N (μF)	R_S ($\text{m}\Omega$)	R_{th} (K/W)	I_{max} (A)	\hat{I} (kA)	I_S (kA)	E_N (Ws)	L_e (nH)	$D_1 \times L_1$ (mm)	Design Maßbild	m (kg)	order no. Bestell-Nr.
U_N 3300V DC		U_S 4950V		U_r 700V		U_{BB} 4950V DC					
7	1.42	7.5	30	1	3	38	15	75 × 56	P57	0.3	E61.M56-702P57
12.5	0.98	4.7	45	1.8	5	68	20	95 × 56	P57	0.48	E61.P56-133P57
24	1.39	3.1	50	1.8	5	131	25	95 × 83	P57	0.7	E61.P83-243P57
U_N 3600V DC		U_S 5400V		U_r 850V		U_{BB} 5400V DC					
6	1.52	7.5	25	0.9	2.8	39	15	75 × 56	P57	0.3	E61.M56-602P57
10	1.09	4.7	40	1.5	5	65	20	95 × 56	P57	0.48	E61.P56-103P57
20.5	1.48	3.1	45	1.6	5	133	25	95 × 83	P57	0.7	E61.P83-213P57
U_N 4000V DC		U_S 6000V		U_r 800V		U_{BB} 6000V DC					
3.5	1.92	7.5	25	0.7	2	28	15	75 × 56	P57	0.3	E61.M56-352P57
6.5	1.24	4.7	40	1.3	4	52	20	95 × 56	P57	0.48	E61.P56-652P57
13	1.78	3.1	45	1.3	4	104	25	95 × 83	P57	0.7	E61.P83-133P57





Design P57

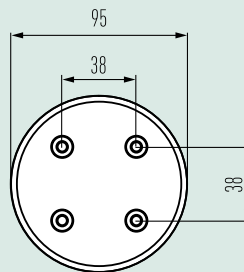
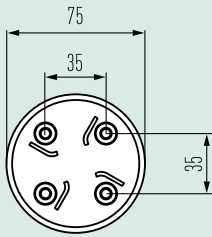
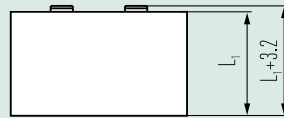
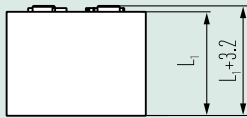

Principal circuit diagram P57
Prinzipschaltbild P57

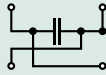

Can material plastic can, filled with PUR resin
Fixing can be fixed by terminals on PCB or bus bar
Terminals internal threads M6i × 5mm
I_{max} (Terminals) 40 A
Degree of protection IP 00
K/L 26 mm
Humidity class F

Gehäusematerial Kunststoff, gefüllt mit Polyurethanharz
Befestigung kann mit Anschlüssen direkt auf Leiterplatte oder Sammelschiene geschraubt werden
Anschlüsse Innengewinde M6i × 5 mm
I_{max} (Anschlüsse) 40 A
Schutzgrad IP 00
K/L 26 mm
Feuchteklasse F



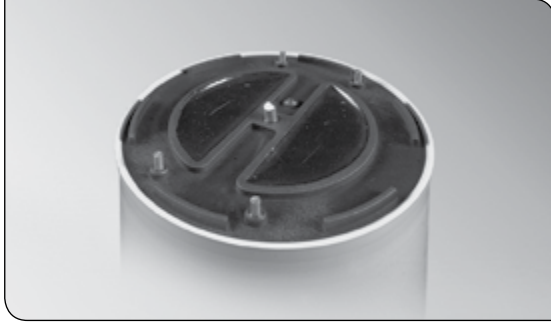

Design P3

Principal circuit diagram P3
Prinzipschaltbild P3

Can material..... flame-retardant plastic can (UL94: V0).
filled with solidified PUR resin

Terminals.....copper wire \varnothing 1.2 mm / 2 mm

I_{max} (Terminals).....35 A

Degree of protection..... IP 00

K.....17.5 mm

L.....17.5 mm

Humidity class..... F

Gehäusematerial.....Flammhemmender Kunststoff (UL94: V0).
gefüllt mit ausgehärtetem Polyurethanharz

Anschlüsse.....Kupferdraht \varnothing 1.2 mm / 2 mm

I_{max} (Anschlüsse).....35 A

Schutzgrad..... IP 00

K.....17.5 mm

L.....17.5 mm

Feuchtklasse..... F



Important Remarks

Safety

ELECTRONICON will not indemnify or be responsible for any kind of damages to persons or property due to the improper application of any capacitors purchased from ELECTRONICON or its distributors.

The capacitors shall only be used for the intended application.

Mind that electrical or mechanical misapplication of capacitors can become hazardous. Misapplied capacitors can explode or catch fire and cause bodily injury or property damage due to the expulsion of material or metal fragments.

Please consult the detailed instructions for mounting and application stated in our brochure „Application Notes“ and on the ELECTRONICON website.

If in doubt about how to connect, operate, or discharge a capacitor, consult ELECTRONICON engineering or our distributors.

Mounting And Cooling

The useful life of a capacitor may be reduced dramatically if exposed to excessive heat. Typically an increase in the ambient temperature of 7°C will halve the expected life of the capacitor. Make sure to obey the permitted operating temperatures.

To avoid overheating the capacitors must be allowed to cool unhindered and should be shielded from external heat sources. We recommend forced ventilation for all applications with detuning reactors.

Give at least 20mm clearance between the capacitors for natural or forced ventilation, and do not place them directly above or next to heat sources such as detuning or tuning reactors, bus bars, etc.

Protection against Overvoltages And Short Circuits:

Self-Healing Dielectric

All dielectric structures used in our power capacitors are „selfhealing“: In the event of a voltage breakdown the metal layers around the breakdown channel are evaporated by the temperature of the electric arc that forms between the electrodes. They are removed within a few microseconds and pushed apart by the pressure generated in the centre of the breakdown spot.

An insulation area is formed which is reliably resistive and voltage proof for all operating requirements of the capacitor. The capacitor remains fully functional during and after the breakdown.

For voltages within the permitted testing and operating limits the capacitors are short-circuit- and overvoltage-proof. They are also proof against external short circuits as far as the resulting surge discharges do not exceed the specified surge current limits.

Wichtige Hinweise

Sicherheit

ELECTRONICON übernimmt keine Verantwortung oder Haftung für jegliche Schäden an Personen oder Eigentum, welche aus der unsachgemäßen Anwendung von bei ELECTRONICON oder seinen Distributoren erworbenen Kondensatoren herrührt.

Die Kondensatoren dürfen ausschließlich für ihren Bestimmungszweck verwendet werden.

Beachten Sie, daß ein elektrisch oder mechanisch fehlerhafter Einsatz von Kondensatoren gefährlich sein kann. Falsch eingesetzte Kondensatoren können explodieren oder Feuer fangen und infolge austretender Materialien bzw. Metallteile gesundheitliche und materielle Schäden verursachen.

Bitte beachten Sie die detaillierten Anweisungen in unserer Broschüre „Anwendungshinweise“ sowie auf der Webseite von ELECTRONICON.

Bitte konsultieren Sie das Fachpersonal von ELECTRONICON oder seine Distributoren bei allen Fragen bezüglich des Anschlusses, der Verwendung oder der Entladung von Kondensatoren.

Montage und Kühlung

Die Lebensdauer eines Kondensators kann durch übermäßige Wärmeeinwirkung erheblich verringert werden. Im allgemeinen führt eine Erhöhung der Umgebungstemperatur um 7°C zu einer Verringerung der Lebensdauer des Kondensators um 50 %. Halten Sie die zugelassenen Betriebstemperaturen ein.

Um Überhitzung zu vermeiden, muß gewährleistet sein, daß die Kondensatoren auftretende Verlustwärme ungehindert abführen können und vor fremden Wärmequellen abgeschirmt werden. Insbesondere bei verdrosselten Anlagen ist in jedem Falle eine Zwangslüftung zu empfehlen. Zwischen den und um die Kondensatoren herum sollten mindestens 20mm Platz für natürliche oder Zwangslüftung belassen werden. Bringen Sie den Kondensator nie direkt neben oder über Wärmequellen, wie Drosseln u. ä. an.

Schutz gegen Überspannungen und Kurzschlüsse: Selbstheilendes Dielektrikum

Alle in unseren Leistungskondensatoren eingesetzten dielektrischen Strukturen sind selbstheilend. Im Falle eines Kurzschlusses (Spannungsdurchschlag) verdampfen die Metallbeläge um den Durchschlagspunkt herum aufgrund der Temperatur des Lichtbogens, der sich zwischen den Elektroden bildet. Innerhalb weniger Mikrosekunden wird der Metalldampf durch den beim Durchschlag entstehenden Überdruck vom Zentrum des Durchschlages weggedrückt. Aus diese Weise bildet sich eine belagfreie Zone rings um den Durchschlagspunkt, wodurch dieser vollständig isoliert wird. Der Kondensator bleibt während und nach dem Durchschlag voll funktionsfähig.

Für Spannungen innerhalb der zugelassenen Test- und Betriebsbedingungen sind die Kondensatoren kurzschluss- und überspannungssicher. Sie sind außerdem sicher gegen äußere Kurzschlüsse, sofern bei den dabei entstehenden Stoßentladungen die zugelassenen Stoßströme nicht überschritten werden.



Failure Rate

The failure probability of a component is a statistical value which is described by a log-normal distribution:

$$N = N_0 \times e^{-\lambda t}$$

λ is the failure rate, which alternatively is also stated as the so-called FIT-rate (FIT = Failures In Time = $\lambda \times 10^9$).

The failure rate is very closely linked with operating temperature and operating voltage of the capacitor. The FIT rates stated in this catalogue are related to the capacitors' rated voltage and a dielectric temperature (= HOTSPOT temperature) of 70°C.

The simultaneous operation of capacitors at highest permissible voltage and operating temperature should be avoided; otherwise, failure rates may increase beyond reasonable technical reliability.

The standard reference period for the failure rate statement is 100.000 hours. Please note that FIT rates can be altered or improved by technical adjustments. Please contact us for details.

The following diagram demonstrates the correlation between FIT rate, operating voltages and operating temperatures.

Ausfallrate

Die Ausfallwahrscheinlichkeit eines Bauelements ist eine statistische Größe, die mit Hilfe einer Normalverteilung beschrieben wird. Es gilt:

N = number of functional components after period t
Anzahl der nach der Zeit t intakten Bauelemente

N_0 = total number of components at time $t = 0$
Gesamtzahl der Bauelemente zum Zeitpunkt $t = 0$

λ = failure rate Ausfallrate

Dabei ist λ die Ausfallrate, die alternativ auch als FIT -Rate angegeben wird (FIT = $\lambda \times 10^9$)

Die Ausfallrate ist stark abhängig von der Temperatur und der Betriebsfeldstärke. Die FIT-Raten im Katalogsortiment beziehen sich auf 70°C Dielektrikumtemperatur (=Hotspot-Temperatur) und die Nennspannung des Kondensators.

Der Betrieb von Kondensatoren mit der höchsten zulässigen Spannung und der höchsten zulässigen Betriebstemperatur sollte vermieden werden, andernfalls können die Ausfallraten so hoch werden, dass keine technisch sinnvollen Zuverlässigkeiten mehr gewährleistet sind.

Der Wert für die Ausfallrate bezieht sich auf einen Referenzzeitraum von 100.000h. FIT-Raten können durch technische Anpassung der Kondensatoren beeinflusst und verbessert werden. Auskünfte hierzu erteilen wir auf Anfrage.

Das nachstehende Kurvendiagramm macht den Zusammenhang von FIT-Rate, Betriebsspannung und Betriebstemperatur deutlich.

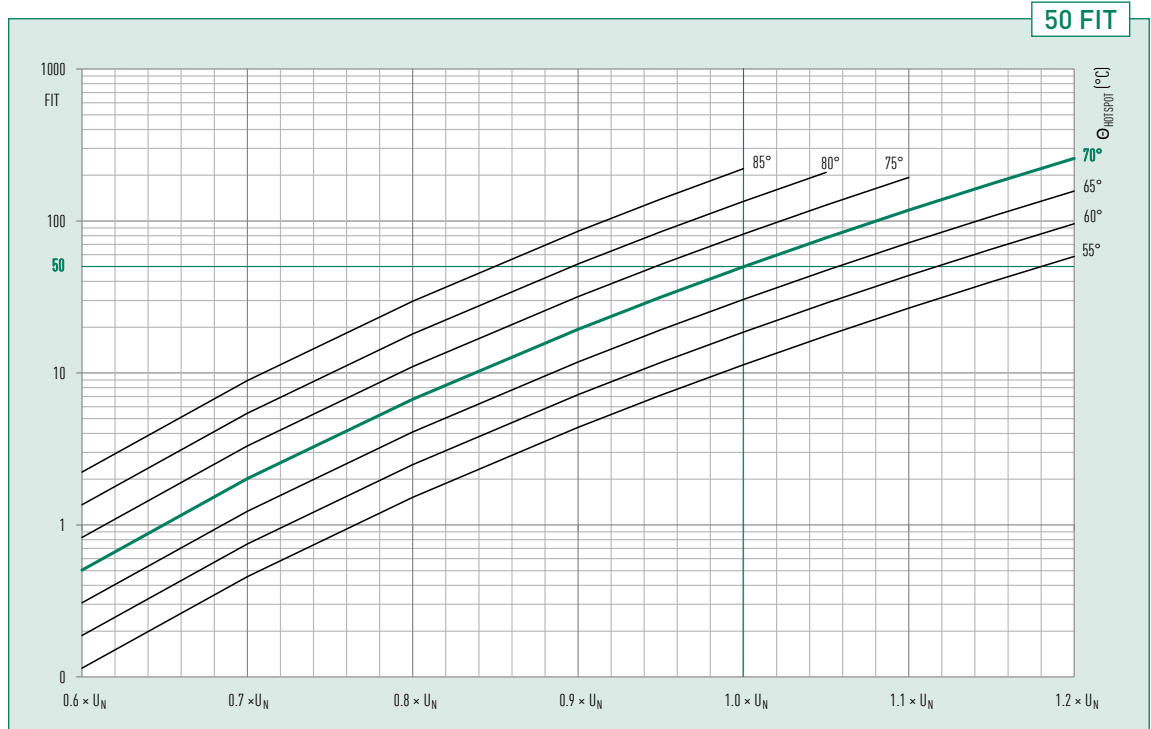

Limited Warranty

All our products are designed, manufactured, and tested with the highest care and workmanship. The satisfaction of our customers is our highest goal. We therefore warrant remedying any defect in the goods resulting from faulty design, materials or workmanship, which appears within 3 years (E61: 2 years) from the date of sale.

This warranty does not cover defects due to improper use of the goods or operation at conditions exceeding the rated values stated in the catalogue or special data sheet. Nor does it cover defects due to faulty maintenance or incorrect installation, alterations or faulty repairs undertaken by the Buyer. Finally the warranty does not cover normal wear and tear or deterioration.

See our „General Conditions“ for details on Warranty and Product liability.

Find more information and detailed instructions in our „Application Notes“ and on www.electronicon.com

Gewährleistung

Alle unsere Erzeugnisse werden mit höchster Sorgfalt und Fachkenntnis entwickelt, hergestellt und geprüft. Die Zufriedenheit unserer Kunden ist unser höchstes Ziel. Wir verpflichten uns daher, jeden innerhalb von 3 Jahren (E61: 2 Jahre) ab Verkaufsdatum auftretenden Mangel an unseren Erzeugnissen zu beseitigen, welcher aus Fehlern in Design, Material oder Herstellung herrührt. Diese Gewährleistung erstreckt sich nicht auf Defekte, welche auf unsachgemäße Anwendung oder Betrieb jenseits der nach Katalog oder speziellem Datenblatt zulässigen Einsatzbedingungen zurückzuführen sind. Sie erfasst ebensowenig Schäden, welche aus fehlerhafter Wartung, unsachgemäßer Montage, Änderungen oder unsachgemäßen Reparaturen durch den Käufer bzw. Anwender resultieren. Schließlich betrifft diese Gewährleistung auch nicht normale Abnutzung und Verschleiß.

Siehe unsere „Allgemeinen Geschäftsbedingungen“ für Details zu Gewährleistung und Produkthaftung.

Mehr Informationen und ausführliche Anweisungen finden Sie in unseren „Anwendungshinweisen“ und unter www.electronicon.com



NOTES
NOTIZEN

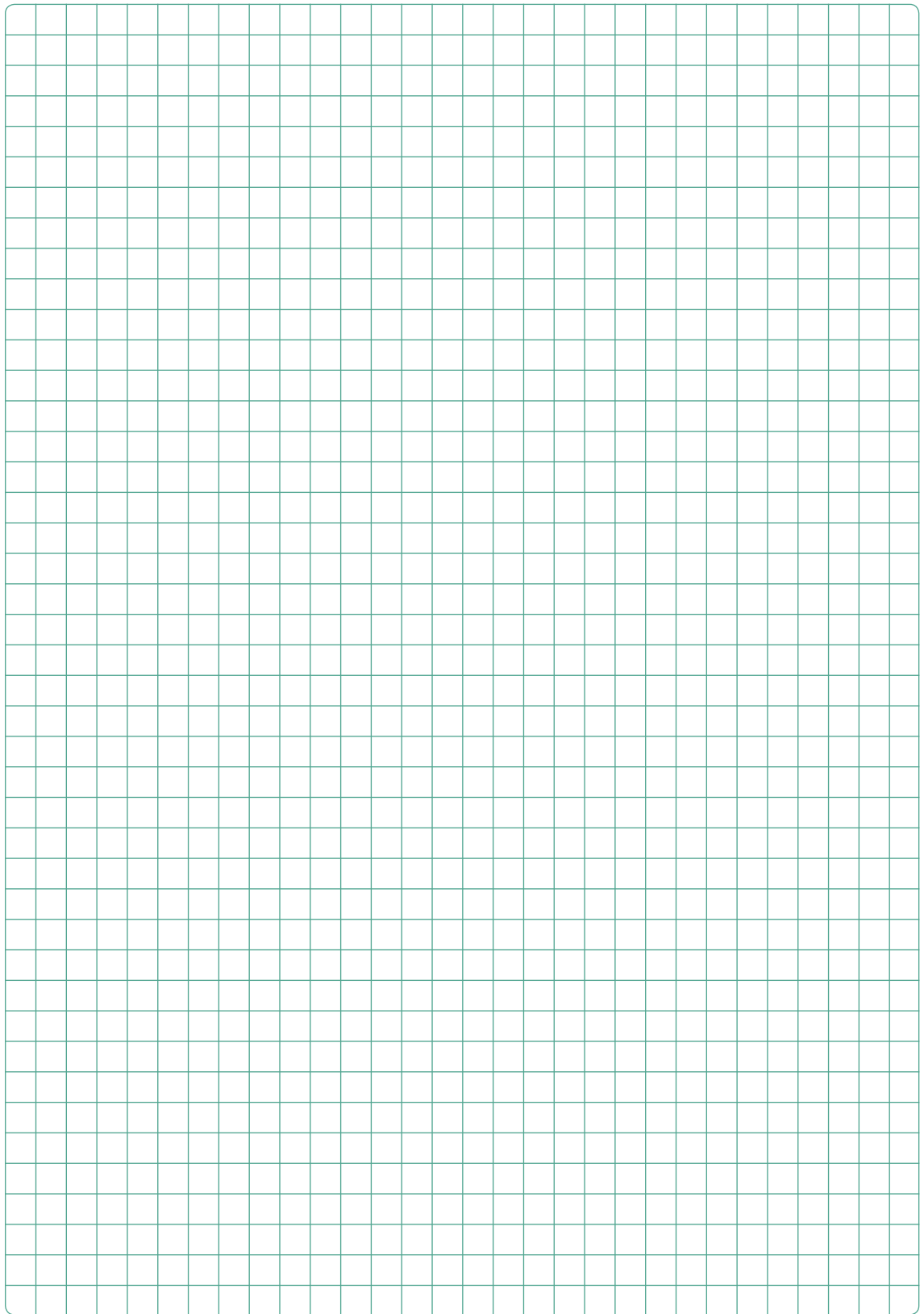

CAPACITORS FOR APPLICATIONS IN POWER ELECTRONICS

www.electronicon.com



E51/E53/E55
AC/DC FILM CAPACITORS



HIGH VOLTAGES, HEAVY CURRENTS, AND LOW INDUCTANCE

ELECTRONICON
always in charge

www.electronicon.com



E57/E59/SR17™ AC AND DC CAPACITORS
WITH LARGE CAPACITANCES



STANDARD OR SPECIAL – YOUR CHOICE

ELECTRONICON
always in charge

www.electronicon.com Issue 1/2018



for latest edition
and updates check
www.powercapacitors.info

PK16™ AND E61
– HIGH DENSITY DC FILM
CAPACITORS



THE IDEAL CHOICE FOR YOUR DC LINK

ELECTRONICON
always in charge

www.electronicon.com



E62 AND E64
HEAVY DUTY AC CAPACITORS



THE PERFECT CHOICE FOR YOUR AC/DC APPLICATION

ELECTRONICON
always in charge

www.electronicon.com



E62-3ph AND 3HF
HEAVY DUTY THREE PHASE AC FILTER CAPACITORS



HIGH-END FOR THE HEART OF YOUR AC FILTER

ELECTRONICON
always in charge

www.electronicon.com



PEC APPLICATION NOTES / ANWENDUNGSHINWEISE



ELECTRONICON
always in charge

always in charge

EXCELLENT EXPERIENCE IN CAPACITOR MAKING FOR OVER 80 YEARS

Gera has been a centre of capacitor making since 1938. ELECTRONICON Kondensatoren GmbH which emerged from previous RFT/VEB ELEKTRONIK Gera in 1992, has become one of Europe's leading capacitor manufacturers supplying customers worldwide and being an open and competent partner for manufacturers and users of power factor correction equipment, for many manufacturers of drives, power electronics, home appliances, and for the lighting industry. Regular investments in advanced and environmentally sound technologies guarantee the highest levels in manufacture and quality to modern standards which are approved and monitored by leading certification authorities.



In today's globalised competition, we distinguish ourselves by

- Absolute reliability and safety of our products
- Close co-operation between manufacturer and client to meet both technical and commercial requirements
- Improvement and development of our technical expertise in capacitor design and manufacture, as well as film coating, with special attention paid to the MKPg-technology
- Early identification and incorporation of new trends and methods in the manufacturing of capacitors
- Flexibility and punctual fulfilment of our commercial obligations

Our experienced development engineers are competent and responsible for both implementing the latest technical trends applicable to our products and ensuring that our products adapt to the challenges of traditional and new markets. The close and intense co-operation between the departments of Marketing & Sales, Research & Development, and Production has become the keystone of our success. ELECTRONICON is continually striving to establish a similarly close and interactive relationship with its distributors and direct clients both in home and overseas markets, to become not just one out of many suppliers, but your preferred partner for ideas and solutions.

ELECTRONICON®

Germany • 07549 Gera • Keplerstrasse 2
Fon +49 365 / 734 61 00 • Fax +49 365 / 734 61 10
E-Mail: sales@electronicon.com, www.electronicon.com

